

Persianas Lamas Orientables / Aluminio
Persiennes Lames Orientables / Aluminium
Movable Blades Shutters / Aluminium

ALUMINIO | ALUMINIUM | ALUMINIUM

laminas orientables | lames orientables | movable blades

Movil Clasico T140

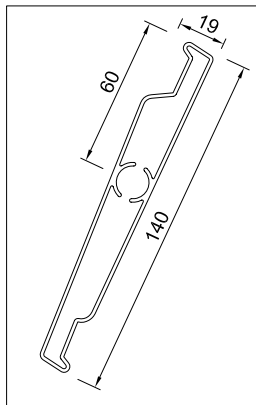

Movil Clasico T110

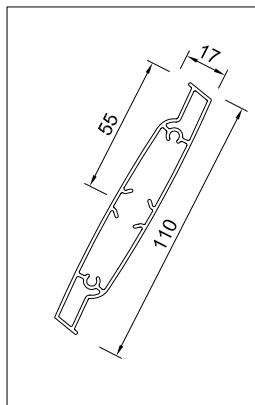

Movil Clasico T80

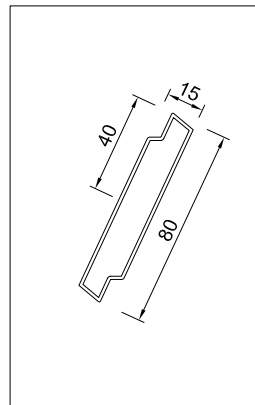

Alba Clasic 70MG

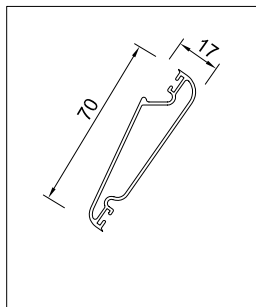

Alba Clasic 60M

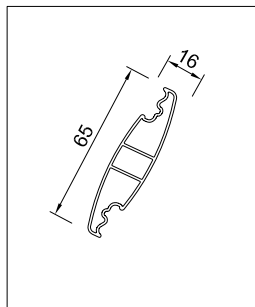

Alba Disseny ALT70

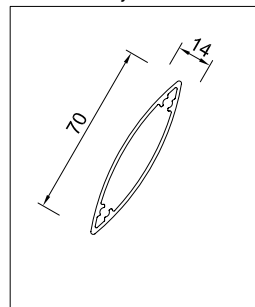

ALUMINIO | ALUMINIUM | ALUMINIUM

laminas orientables | lames orientables | movable blades

modelos | modèles | models

bastidor cadre frame	lama lame blade	modelos modèles models	E	soluciones constructivas solutions constructives constructive solutions	posición lama position lame blade position		ancho max lama longueur max lame max lenght blade		opciones options options			
					H	V	H	V	paso variable pas variable variable pitch	testeros embouts endplates		accionamiento commande operation
										ALU	PA6	
40N.C	T80	T80/40N.C	40mm	■	✓	✓	1600	2000	↕		●	👤 ⚙️ ⚡
	T110	T110/40N.C	40mm	■	✓	✓	1800	2100	↕	●	●	👤 ⚙️ ⚡
	T140	T140/40N.C	40mm	■	✓	✓	2000	2200	↕	●	●	👤 ⚙️ ⚡
	ALT70	ALT70/40N.C	40mm	■	✓	✓	1600	2000	↕		●	👤 ⚙️ ⚡
60N.C	T80	T80/60N.C	40mm	■	✓	✓	1600	2000	↕		●	👤 ⚙️ ⚡
	T110	T110/60N.C	40mm	■	✓	✓	1800	2100	↕	●	●	👤 ⚙️ ⚡
	T140	T140/60N.C	40mm	■	✓	✓	2000	2200	↕	●	●	👤 ⚙️ ⚡
	ALT70	ALT70/60N.C	40mm	■	✓	✓	1600	2000	↕		●	👤 ⚙️ ⚡
40SC.C	T80	T80/40SC.C	40mm	●	✓	✓	1600	2000	↕		●	👤 ⚙️ ⚡
	T110	T110/40SC.C	40mm	●	✓	✓	1800	2100	↕	●	●	👤 ⚙️ ⚡
	T140	T140/40SC.C	40mm	●	✓	✓	1600	2100	↕	●	●	👤 ⚙️ ⚡
	ALT70	ALT70/40SC.C	40mm	●	✓	✓	1600	2000	↕		●	👤 ⚙️ ⚡
60SC.C	T80	T80/60SC.C	40mm	●	✓	✓	1600	2000	↕		●	👤 ⚙️ ⚡
	T110	T110/60SC.C	40mm	●	✓	✓	1800	2100	↕	●	●	👤 ⚙️ ⚡
	T140	T140/60SC.C	40mm	●	✓	✓	1600	2100	↕	●	●	👤 ⚙️ ⚡
	ALT70	ALT70/60SC.C	40mm	●	✓	✓	1600	2000	↕		●	👤 ⚙️ ⚡
60AB	60M	60M/60AB	40mm	●	✓	✓	1200	1200			●	👤 ⚡
	70MG	70MG/60AB	40mm	●	✓	✓	1200	1200			●	👤 ⚡

* Ancho máximo sin travesaños vertical | * largeur max sans montant central | * maximum width without vertical transom

E= espesor bastidor | épaisseur de cadre | frame thickness

soluciones constructivas | solutions constructives | constructive solutions

■ marco fijo | cadre fixe | fixed frame

▲ fijo y corredera | fixe & coulissant | fixe & sliding

● todas | tous | all

👤 manual | manuelle | manualy

⚙️ mecánico | mécanique | mechanical

⚡ motor | moteur | motor

ALUMINIO | ALUMINIUM | ALUMINIUM
laminas orientables | lames orientables | movable blades

T140



T110



T80



ALT70



70MG



60M



ALUMINIO | ALUMINIUM | ALUMINIUM
 lamas orientables | lames orientables | movable blades

cotas principales
 dimensions principales
 main dimensions

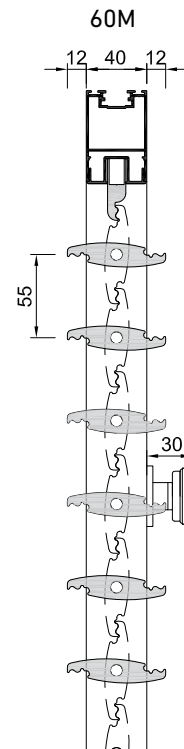
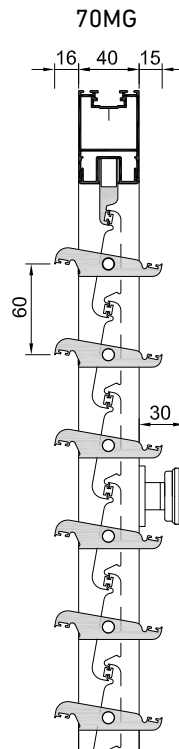
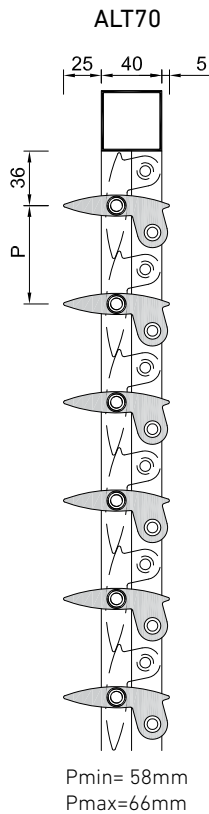
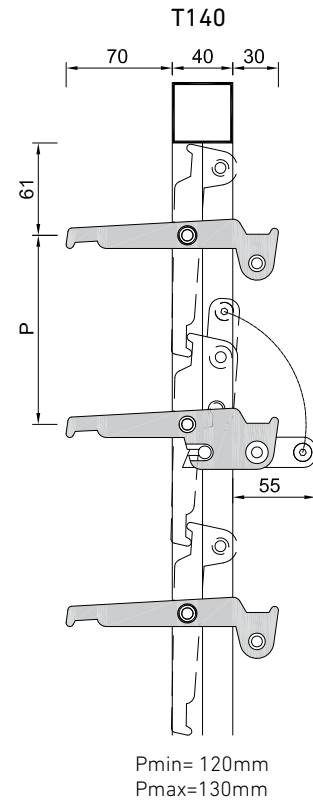
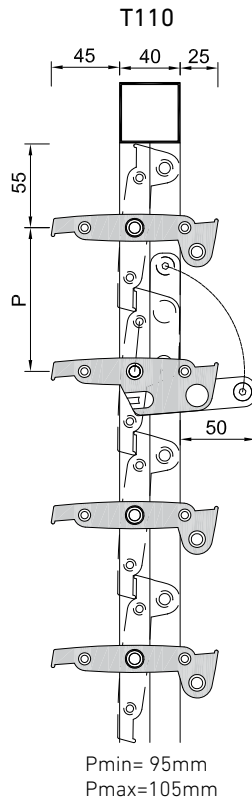
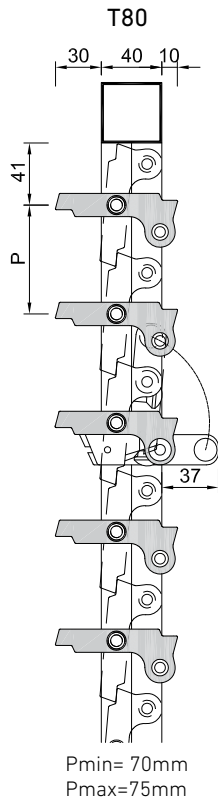

ALUMINIO | ALUMINIUM | ALUMINIUM
laminas orientables | lames orientables | movable blades

ALT70



T80



T110



T140



ALT70



T80



T110



T140





T80/40N.C



T110/60N.C





T140/60N.C



T140/60SC.C