

Brise Soleil Orientables / Madera
Brise-Soleil Orientables / Bois
Movable Solar Shading Louvers / Timber

brise soleil

madera | *bois* | *timber*

lama orientable gran formato | *lame orientable grand format* | *large format movable blade*



brise soleil

madera | *bois* | *timber*

lama orientable gran formato | *lame orientable grand format* | large format movable blade



brise soleil

madera | bois | timber

lama orientable gran formato | lame orientable grand format | large format movable blade

lamas | lames | blades

WR

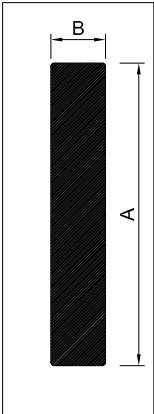

WA

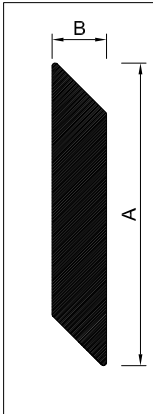

	A (mm)	B (mm)
WR.200	200	36
WR.250	250	36
WR.300	300	42
WR.350	350	48
WR.400	400	48
WA.200	200	36
WA.250	250	36
WA.300	300	42
WA.350	350	48
WA.400	400	48

WT.250

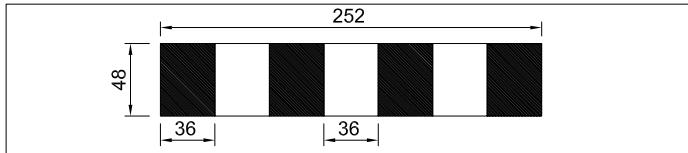

WT.320

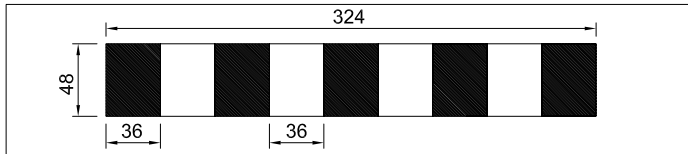

WT.400

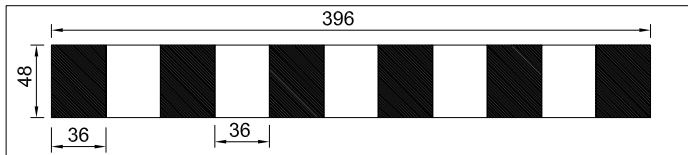

montantes | montants | mullions

arrastre | barre de manouvre | drive road

M80.65

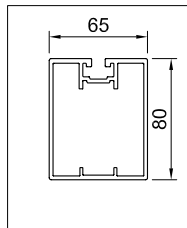

M45.65

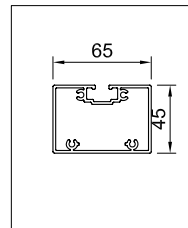

A40.10

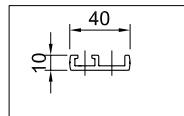

A25.10

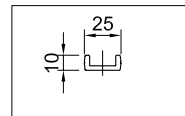

brise soleil

madera | bois | timber

lama orientable gran formato | lame orientable grand format | large format movable blade

ejes | axes | axes

EFJ

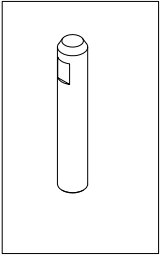

rótula | rotule | kneecap

KRT

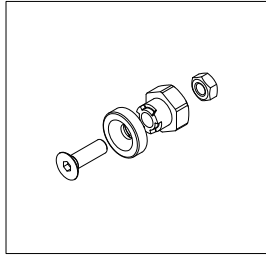

testeras | embouts | endplates - ALU 4mm

T.WA.40

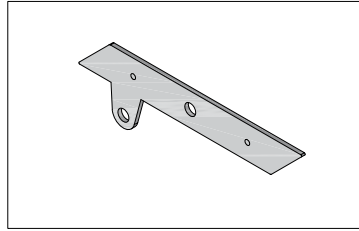

T.WA.20

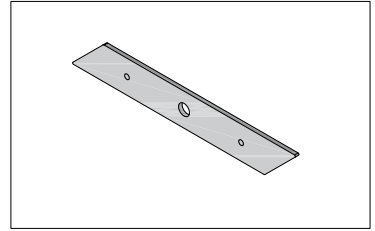

Anilla eje 8mm & 12mm / circlip 8mm & 12mm

A12

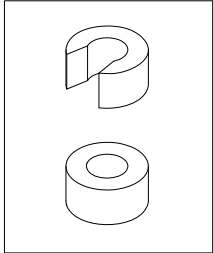

A08

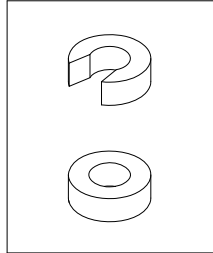

T.WR.40 / T.WT.40

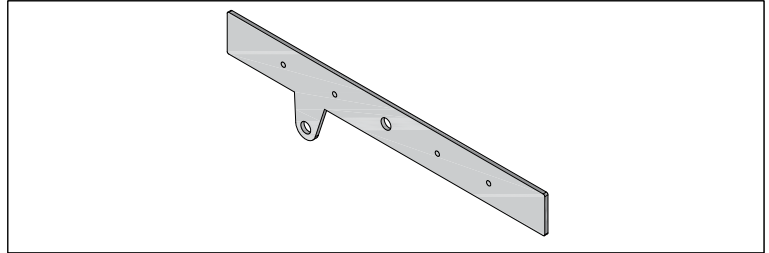

casquillo pivotación | canon épaulé | bearing support

CPT

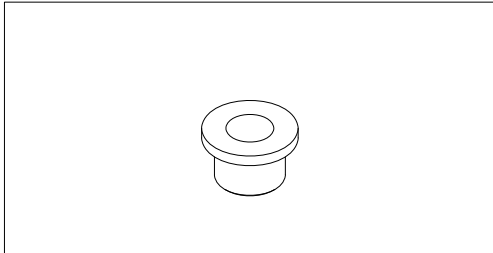

T.WR.20 / T.WT.20

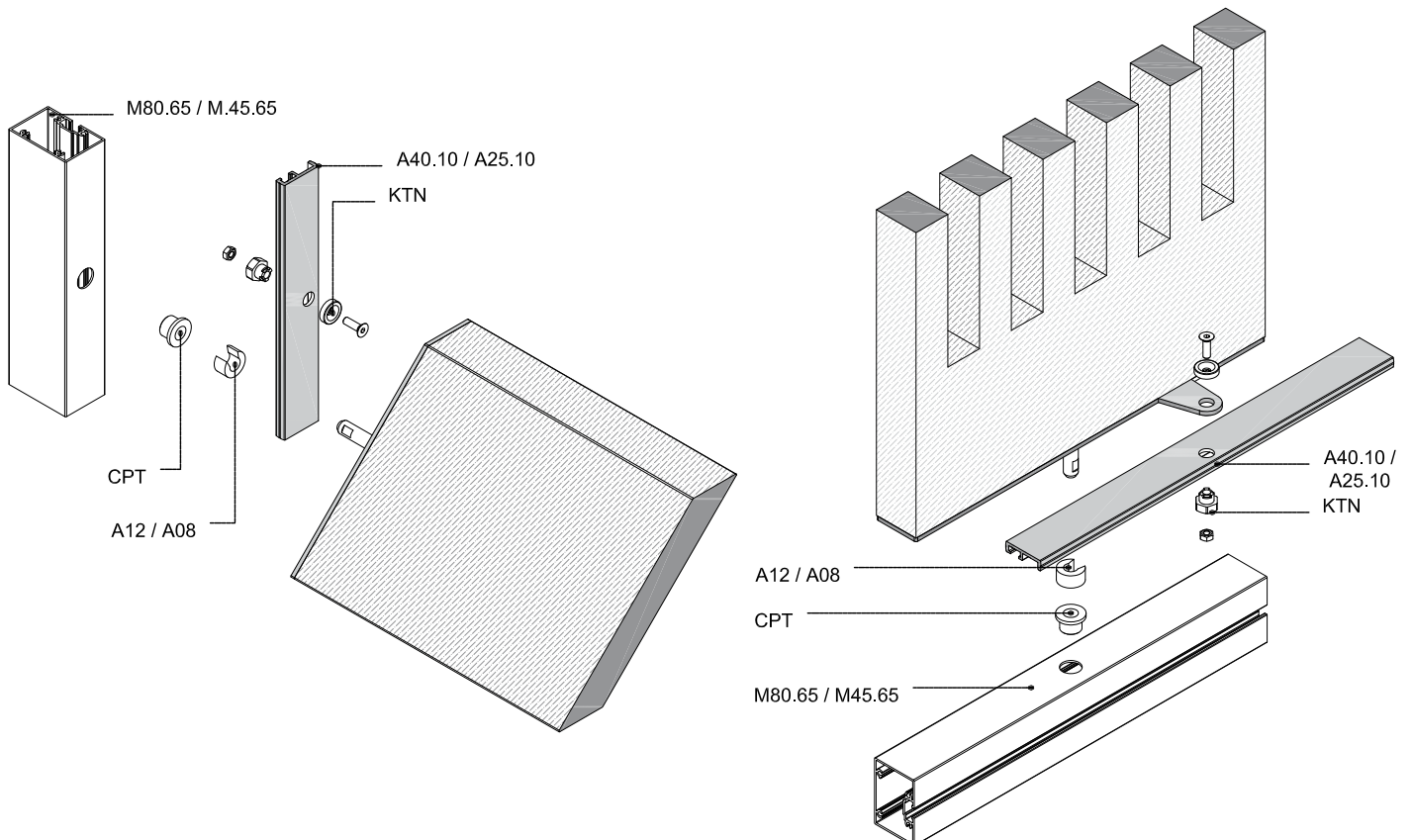
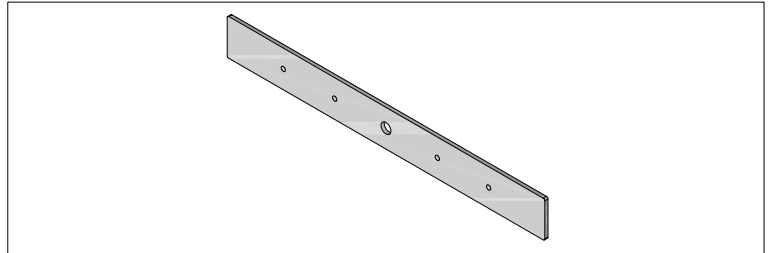

brise soleil

madera | bois | timber

lama orientable gran formato | lame orientable grand format | large format movable blade

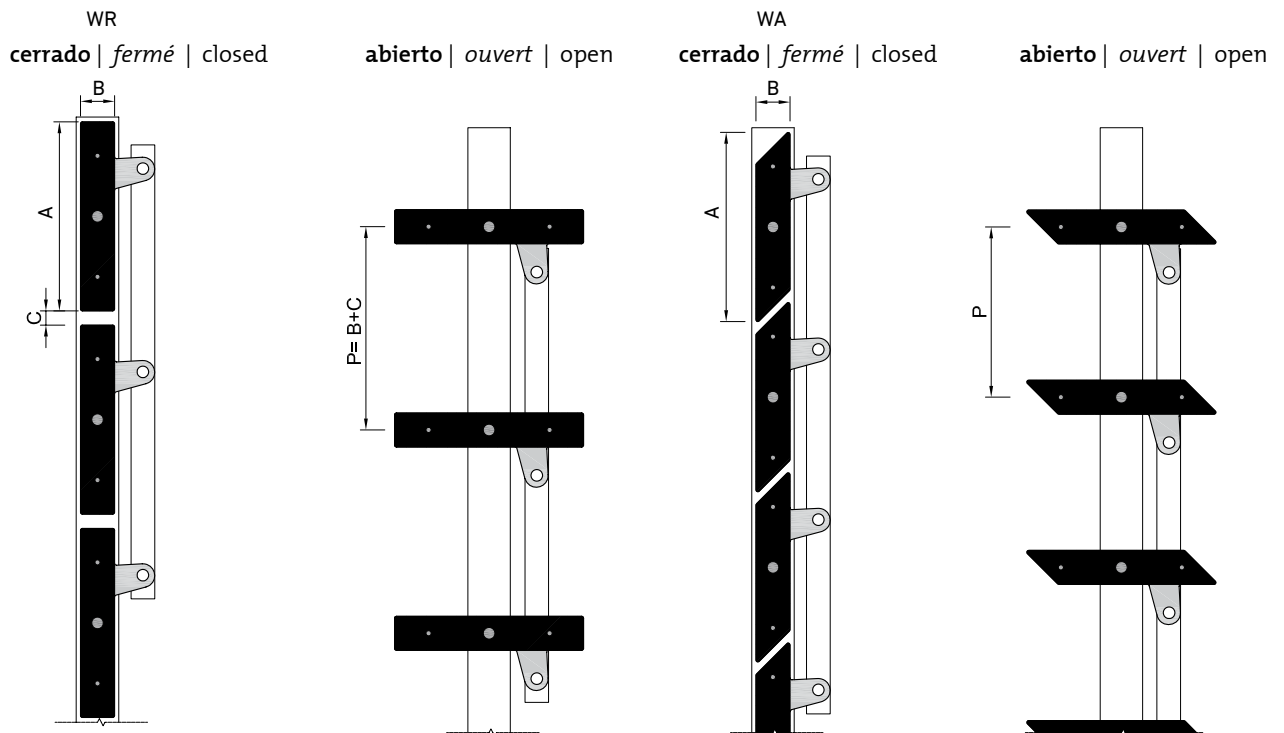

modelo modèle model	cotas principales dimensions principales main dimensions				madera bois timber		
	A (mm)	B (mm)	C Min (mm)	P Min (mm)	maciza massif solid	unión dentada abouté finger joint	laminada lamelle-collé glued laminated
WR.200	200	36	15	B+C	✓	●	●
WR.250	250	36	15	B+C	✓	●	●
WR.300	300	42	15	B+C		●	✓
WR.350	350	48	15	B+C		●	✓
WR.400	400	48	15	B+C		●	✓
WA.200	200	36		175	✓	●	●
WA.250	250	36		225	✓	●	●
WA.300	300	42		270		●	✓
WA.350	350	48		315		●	✓
WR.400	400	48		370		●	✓
WT.250	252	48	20	B+C	✓	●	
WT.320	324	48	20	B+C	✓	●	
WT.400	396	48	20	B+C	✓	●	

(*) Medidas indicativas. Variable según especie | mesures indicatives. Variables selon les espèces | indicative measures. Variable according to species

● dependiendo del largo | en fonction de la longueur | depending on the length

● según la especie | selon les espèces | according to species

✋ manual | manuelle | manually

⚙️ mecánico | mécanique | mechanical

⚡ motor | moteur | motor

brise soleil

madera | bois | timber

lama orientable gran formato | lame orientable grand format | large format movable blade

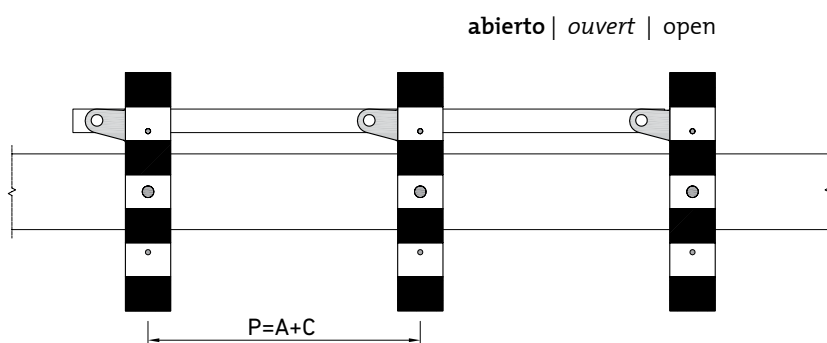
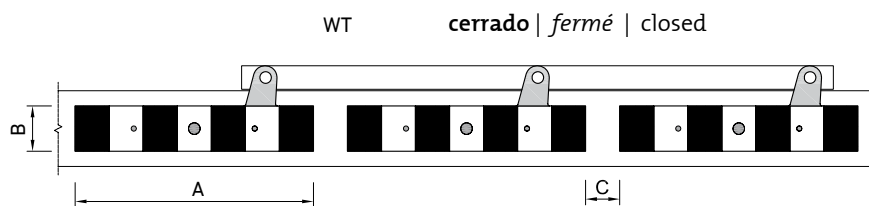

posición lama position lame blade position		largo máximo lama (*) longueur max lame (*) max length blade (*)		accionamiento commande operation
H	V	H	V	
✓	✓	1800	2500	🧤 ⚡
✓	✓	1800	2500	🧤 ⚡
✓	✓	2000	3000	🧤 ⚡
✓	✓	2000	3000	🧤 ⚡
✓	✓	2000	3000	🧤 ⚡
✓	✓	1800	2500	🧤 ⚡
✓	✓	1800	2500	🧤 ⚡
✓	✓	2000	3000	🧤 ⚡
✓	✓	2000	3000	🧤 ⚡
	✓		3000	🧤 ⚡
	✓		3000	🧤 ⚡
	✓		3000	🧤 ⚡





centro de investigación | *centre de recherche* | research center
WT.400
WD Arquitectos
Madrid